

SLIDING DOOR SOFT CLOSE, SELF CLEANING GLIDE

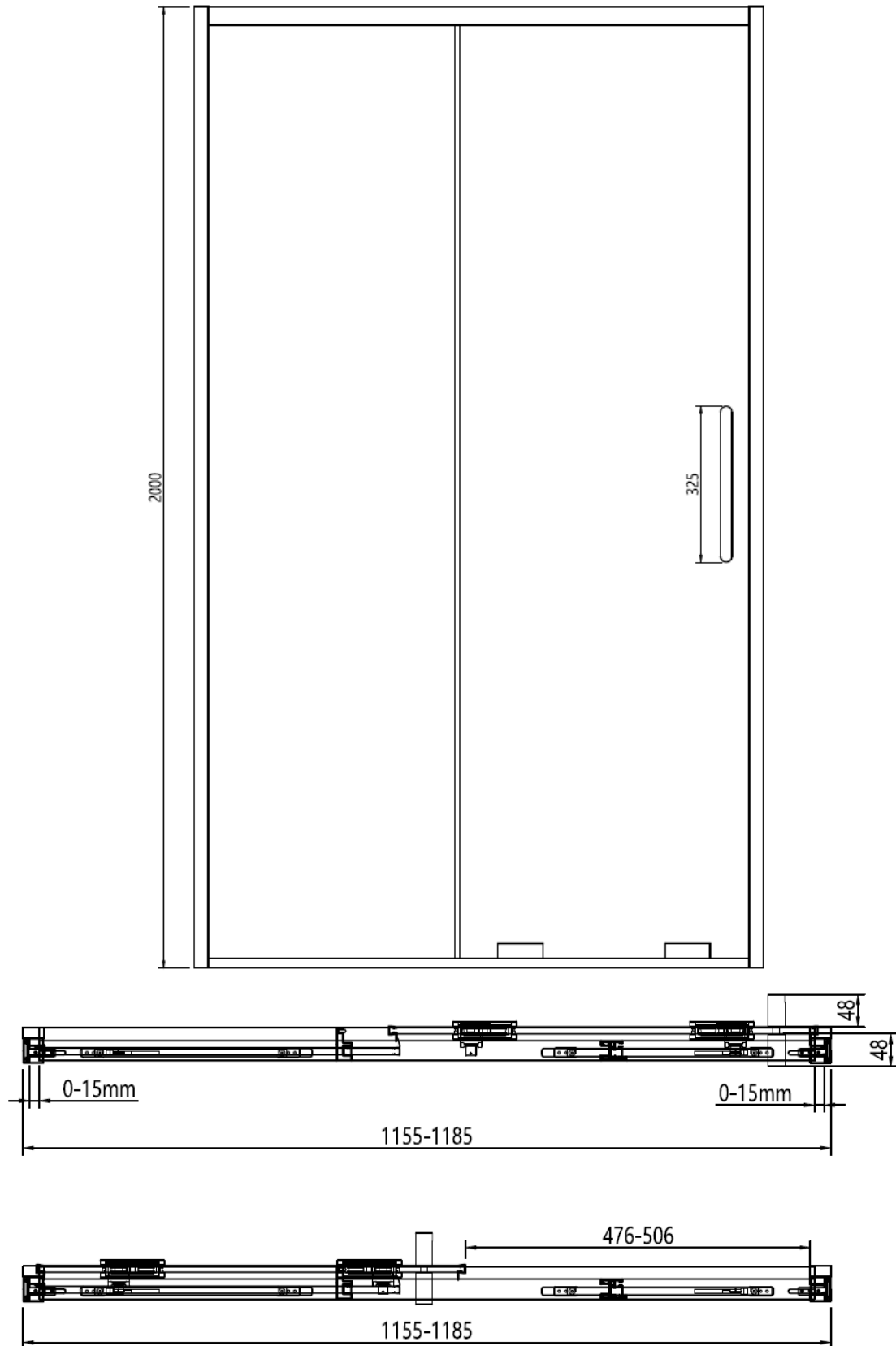

Toughened Glass
Strong and safe



Protective Finish
Easy to clean



Lifetime Guarantee
Peace of mind

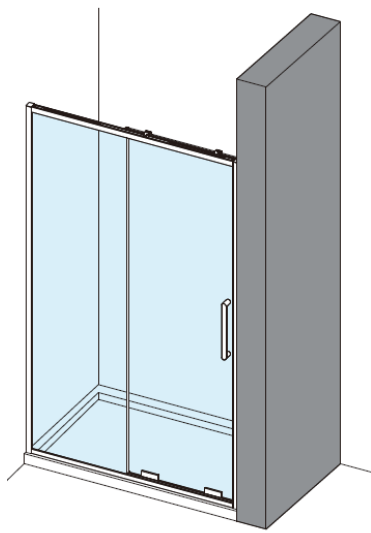

Left Hand

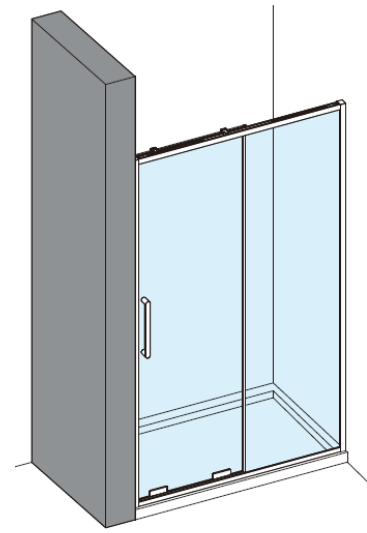

Right Hand



The bottom rollers are fitted with a specially designed brush comes with a brush (the black part marked with red arrow). The brush will clean the track during opening and closing of the moving door, and to ensure the rollers smoothly run on the track, assisting the soft close open and closing mechanism.

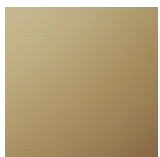
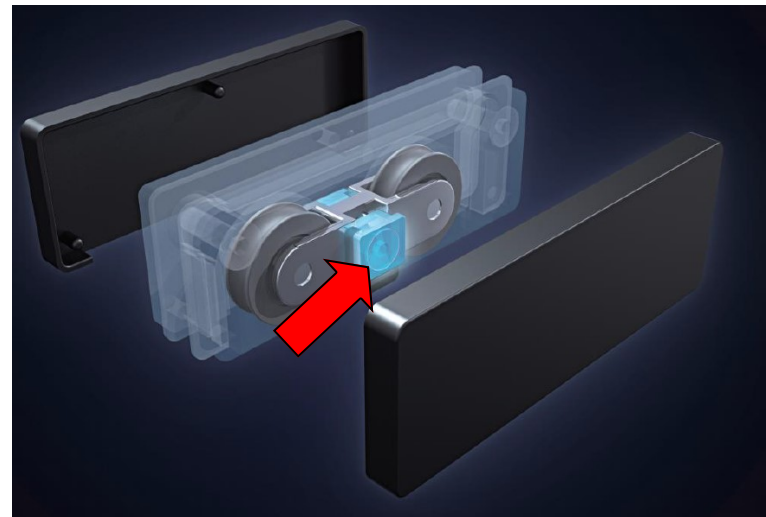

Brushed Brass

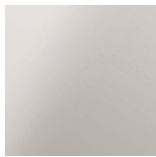

Polished Stainless



Brushed Stainless

CODE	SLIDING DOOR	ADJUSTMENT	DOOR OPENING	Width	Height
	COLOUR	mm	mm	mm	mm
OXSLFC1200	Brushed Brass	1155-1185	476	1200	2000
OXSLSC1200	Polished Stainless Steel	1155-1185	476	1200	2000
OXSLVC1200	Brushed Stainless Steel	1155-1185	476	1200	2000

1200 mm door and 800 side panel

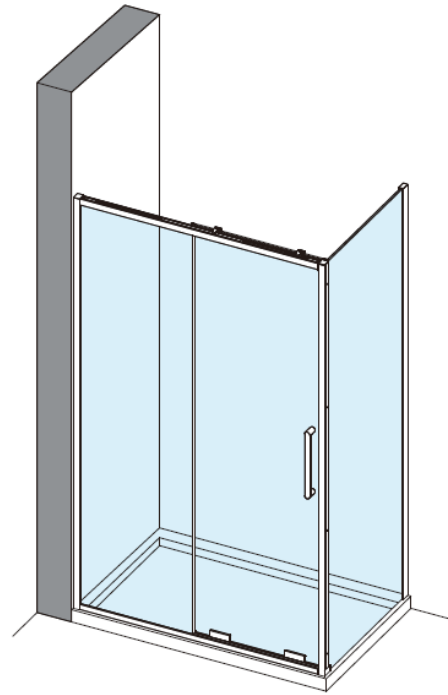
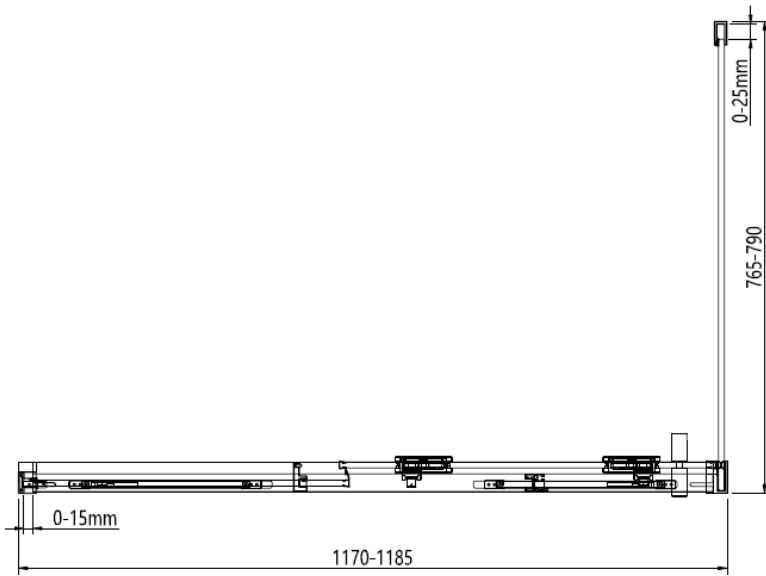

Left Hand

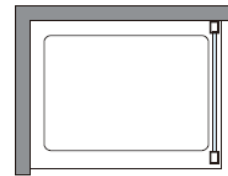

1200 mm door and 900 side panel

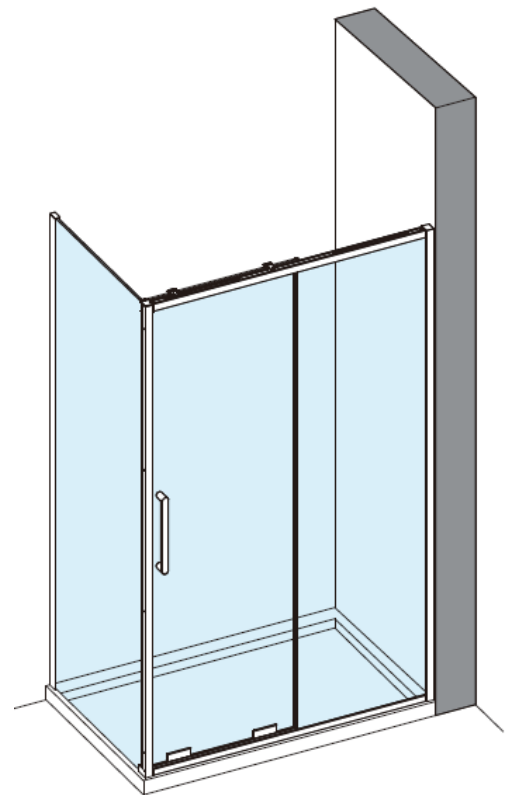
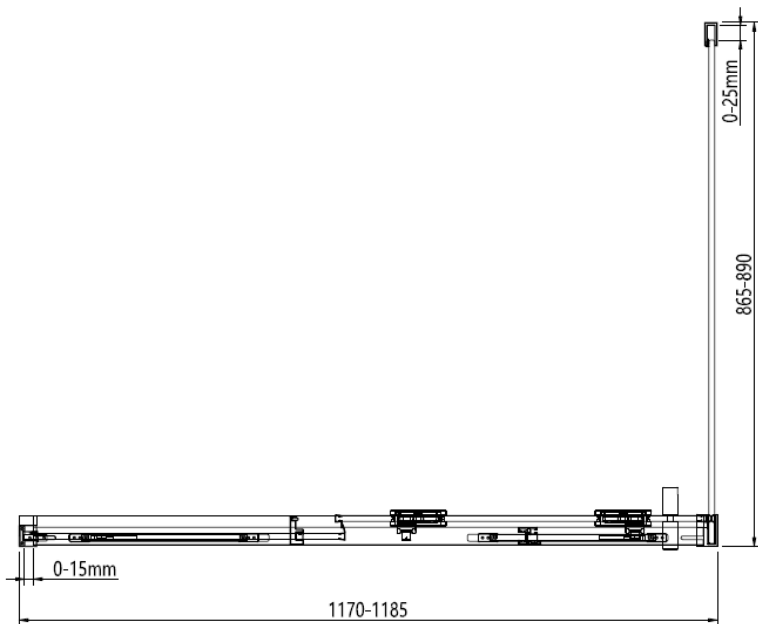

Right Hand

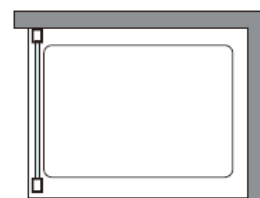

Toughened Glass
Strong and safe



Protective Finish
Easy to clean



Lifetime Guarantee
Peace of mind

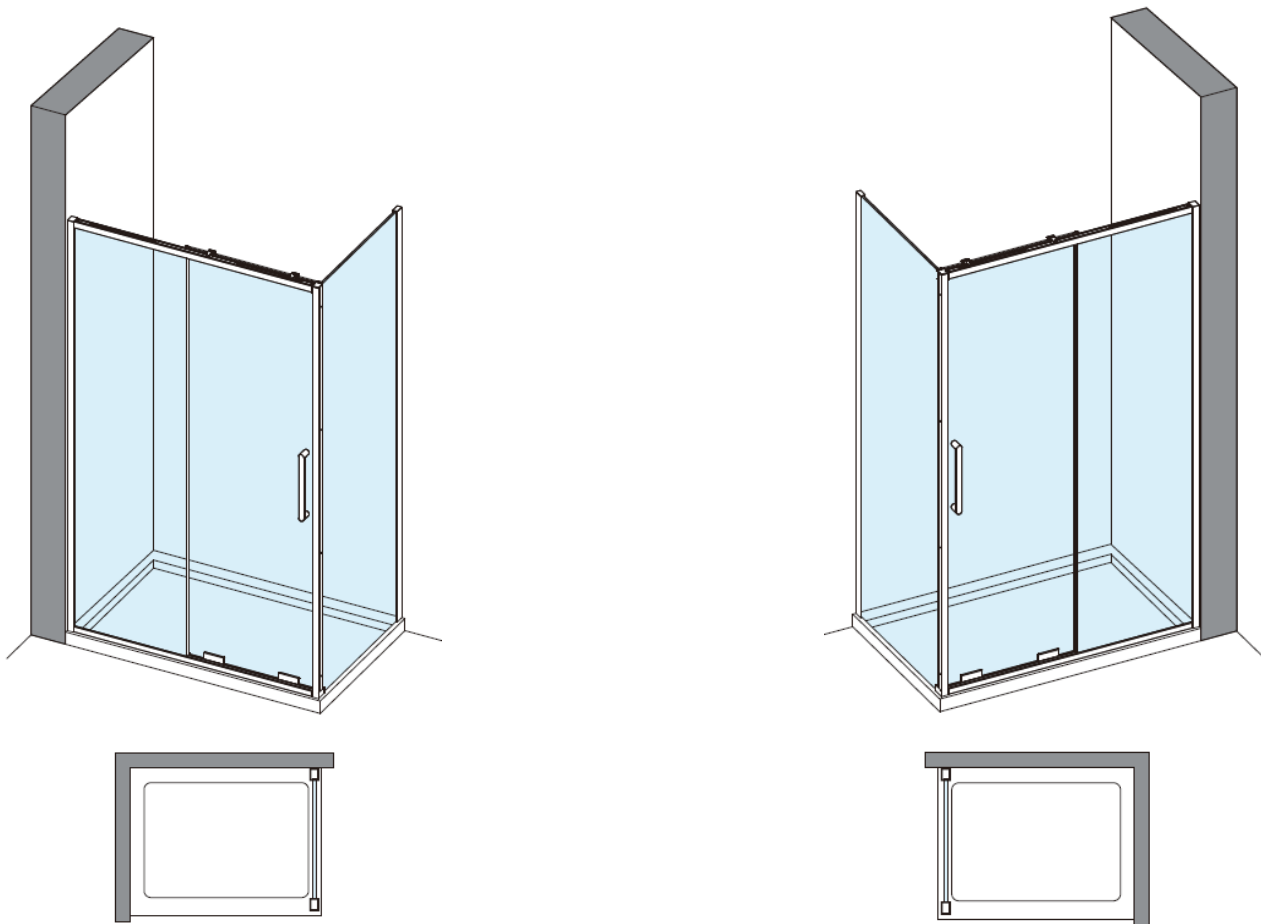

Brushed Brass



Polished Stainless



Brushed Stainless

CODE	SLIDING DOOR	ADJUSTMENT with Side Panel	DOOR OPENING	Width	Height
	COLOUR	mm	mm	mm	mm
OXSLFC1200	Brushed Brass	1170-1195	476	1200	2000
OXSLSC1200	Polished Stainless Steel	1170-1195	476	1200	2000
OXSLVC1200	Brushed Stainless Steel	1170-1195	476	1200	2000

CODE	SLIDING DOOR SIDE PANEL	ADJUSTMENT	DOOR OPENING	Width	Height
	COLOUR	mm	mm	mm	mm
OXSLSPFC0800	Brushed Brass	765-790	NA	800	2000
OXSLSPSC0800	Polished Stainless Steel	765-790	NA	800	2000
OXSLSPVC0800	Brushed Stainless Steel	765-790	NA	800	2000
OXSLSPFC0900	Brushed Brass	865-890	NA	900	2000
OXSLSPSC0900	Polished Stainless Steel	865-890	NA	900	2000
OXSLSPVC0900	Brushed Stainless Steel	865-890	NA	900	2000

1200 mm door and 800 side panel

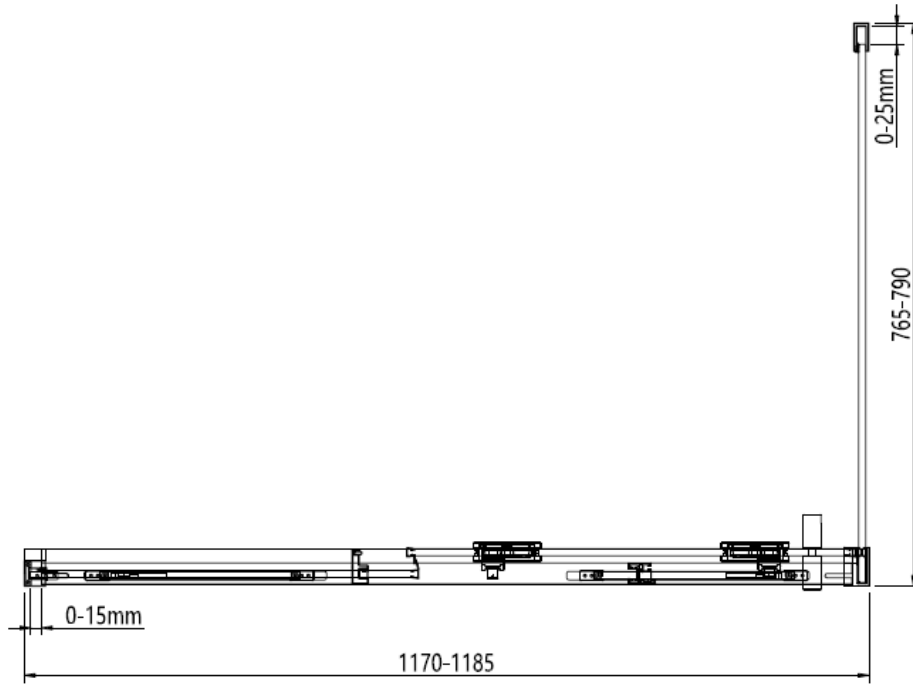



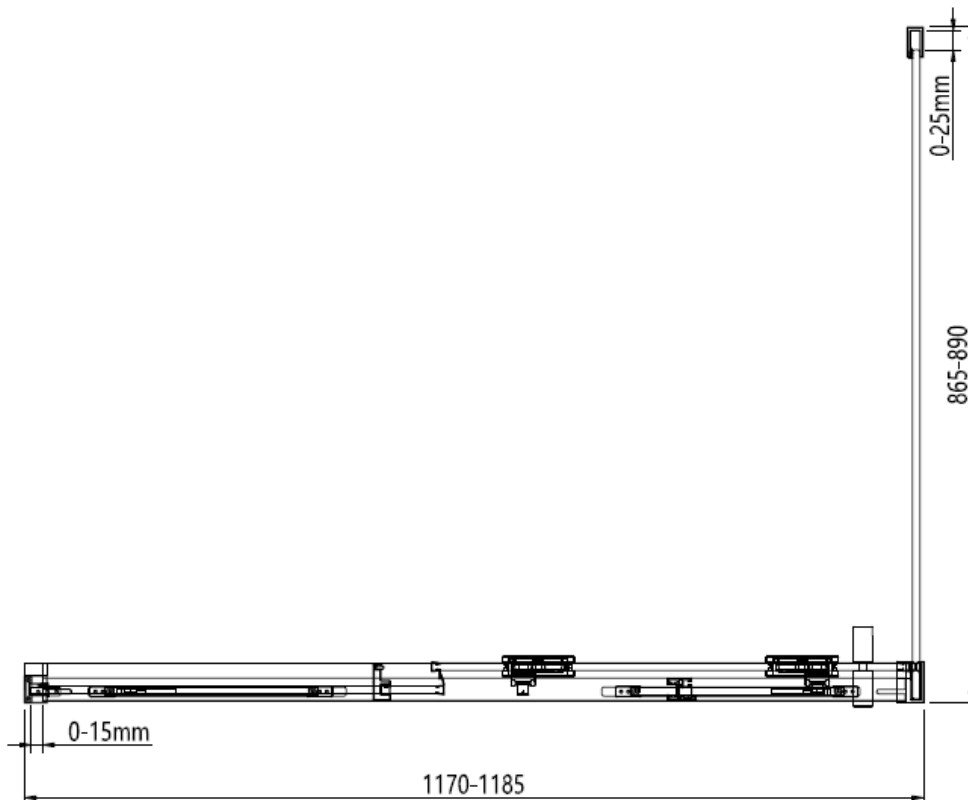





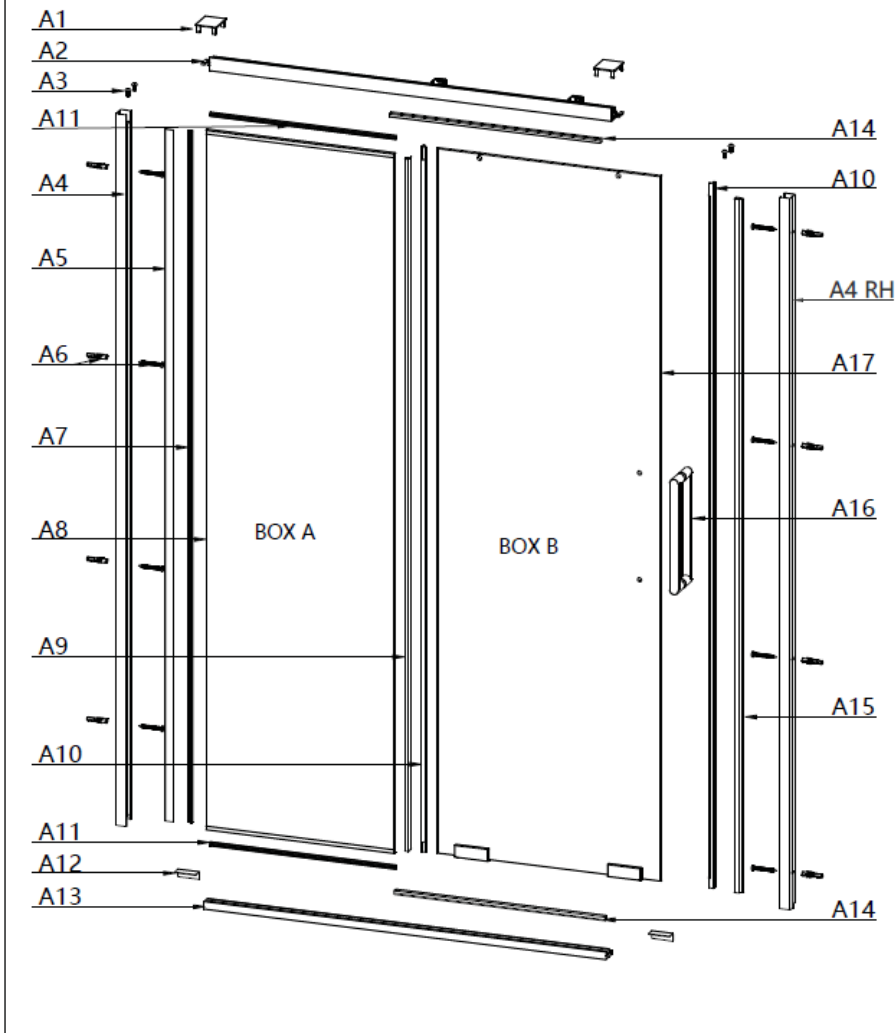





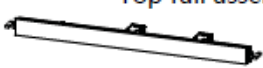



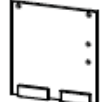

1200 mm door and 900 side panel



Optix 10 Soft Close Sliding Door

Manufactured to: BS EN 14428



A 1	Wall profile cover cap  x2	A 8	Fixed panel assembly  x1	A 15	Closing side wall profile cover  x1
A 2	Top rail assembly  x1	A 9	Fixed panel water seal  x1	A 16	Handle  x1
A 3	Round head hex screw M4*10  x4	A 10	Moving panel seal  1+1	A 17	Moving panel  x1
A 4	Wall profiles  1L+1R	A 11	Fixed panel top and bottom seals  x2	A 18	Allen Key 4mm 3mm 2.5mm 
A 5	Long seal for fixed panel  x1	A 12	Bottom rail end cap  x2	A 19	Wedge gasket tool  x1
A 6	Wall plug and 4x35mm screw  8+8	A 13	Bottom rail  x1	B 9	PVC spacer  x4
A 7	Wall profile seal  x1	A 14	Top & bottom profile trim  x2	B 8	Wall profile cover cap  x1



Optix 10 Side Panel for Slider

